

Sensing range
8 mm

Inductive sensor

- Enhanced sensing range
- Short-circuit protection (pulsed)
- Robust brass housing, nickel-plated with fine thread M18 x 1 mm
- Enclosure rating IP 67
- Installation flush

Dimensional drawing

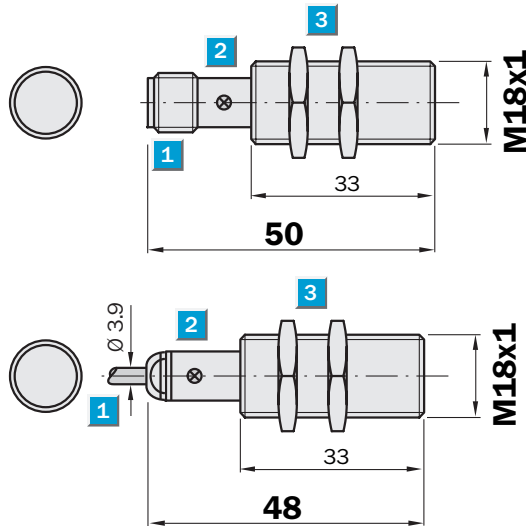

- 1 Connection
- 2 Display LED
- 3 Fastening nuts (2 x); width across 24, metal



Connection type

IME18-08BNOZCOK	IME18-08BNOZW2K	IME18-08BNSZCOK
IME18-08BPOZCOK	IME18-08BNSZW2K	IME18-08BPSZCOK
	IME18-08BPOZW2K	
	IME18-08BPSZW2K	

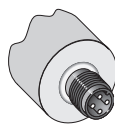

M12, 4-pin

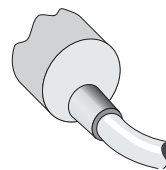
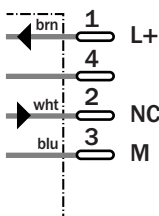

3 x 0.25 mm²

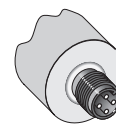
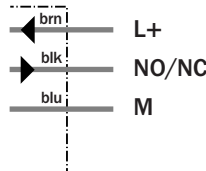

M12, 4-pin

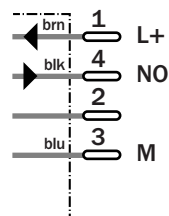

Accessories

Connector, M12, 4-pin

Mounting systems

Technical specifications		IME18-	08BNO ZCOK	08BNO ZW2K	08BNS ZCOK	08BNS ZW2K	08BPO ZCOK	08BPO ZW2K	08BPS ZCOK	08BPS ZW2K		
Sensing range S_n	8 mm											
Electrical configuration	DC3-wire											
Supply voltage V_s	DC 10 ... 30 V											
Nominal voltage V_n	DC											
Ripple U_{pp}	≤ 10 %											
Voltage drop U_d	≤ 2 V ¹⁾											
Power consumption	≤ 10 mA ²⁾											
Continuous current I_a	≤ 200 mA											
Time delay before availability t_v	≤ 100 ms											
Hysteresis H, of s_r	5 ... 15 %											
Repeatability R	≤ 2 % (U_b and T_a constant) ³⁾											
Temperature drift, of s_r	± 10 %											
EMC	According to EN 60947-5-2											
Switching output	NPN											
	PNP											
Output function	Normally closed											
	Normally open											
Installation	Flush											
Connection type	Connector, M12, 4-pin											
	Cable, PVC, 2 m											
Enclosure rating	IP 67 ⁴⁾											
Max. switching frequency	1000 Hz											
Dimensions	M18 x 1 ⁵⁾											
Short-circuit protection	✓ ⁶⁾											
Reverse polarity protection	✓											
Power-up pulse suppression	✓											
Shock/vibration stress	30 g, 11 ms/10 ... 55 Hz, 1 mm											
Ambient temperature T_a	-25 °C ... +75 °C											
Housing material	Brass nickel-plated, plastic (PA6)											
Tightening torque	40 Nm											
Approvals												
Protection class	<input type="checkbox"/>											
UL approval	cULus Listed											

¹⁾ At I_a max
²⁾ Without load

³⁾ Of s_r
⁴⁾ According to EN 60529

⁵⁾ Thread diameter x pitch (mm)
⁶⁾ (Pulsed)

Reduction factor R_M

The following are reference values, which may vary from type to type:

St37 (Fe)	1
Stainless steel (V2A)	Approx. 0.8
Aluminum (solid)	Approx. 0.45
Copper (Cu)	Approx. 0.4

Ordering information

Type	Part Number
IME18-08BNOZCOK	1040977
IME18-08BNOZW2K	1040979
IME18-08BNSZCOK	1040973
IME18-08BNSZW2K	1040975
IME18-08BPOZCOK	1040969
IME18-08BPOZW2K	1040971
IME18-08BPSZCOK	1040965
IME18-08BPSZW2K	1040967

Installation notes

Flush installation in metal

The sensor can be embedded in the metal up to the sensing face.

Proximity sensors for flush installation have a smaller sensing range compared to proximity sensors for non-flush installation with the same shape and design.

General installation notes for cylindrical design for flush installation in metal:

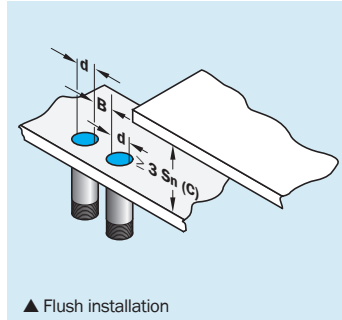

Standard series	
Type	Metal-free zone [mm]
IME08-1B5...	B = 8, C = 4,5
IME12-02B...	B = 12, C = 6
IME18-05B...	B = 18, C = 15
IME30-10B...	B = 30, C = 30

Advanced-Reihe	
Type	Metal-free zone [mm]
IME08-02B...	B = 16, C = 6
IME12-04B...	B = 24, C = 12
IME18-08B...	B = 36, C = 24
IME30-15B...	B = 60, C = 45

d = Outer diameter of the sensor

Installation notes

Non-flush installation in metal

With proximity sensors for non-flush installation, a metal-free zone must be maintained owing to the scattered field distribution.

General installation notes for cylindrical design for non-flush installation in metal:

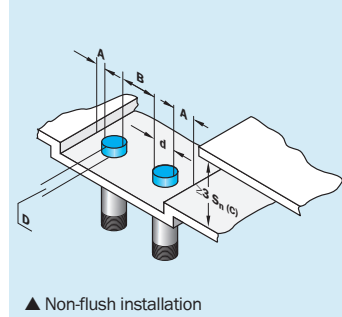

d = Outer diameter of the sensor

Standard series	
Type	Metal-free zone [mm]
IME08-2N5...	A = 8, B = 16, C = 7,5, D = 6
IME12-04N...	A = 12, B = 24, C = 12, D = 8
IME18-08N...	A = 18, B = 36, C = 24, D = 16
IME30-15N...	A = 30, B = 60, C = 45, D = 30

Advanced series	
Type	Metal-free zone [mm]
IME08-04N...	A = 8, B = 18, C = 12, D = 8
IME12-08N...	A = 12, B = 24, C = 24, D = 16
IME18-12N...	A = 18, B = 36, C = 36, D = 24
IME30-20N...	A = 30, B = 60, C = 60, D = 40

Opposite installation in metal

